

# FIBER LASER

## Technologies

HD-F / HD-FL  
HD-FS  
HD-F BH  
HD-FA  
HD-FO

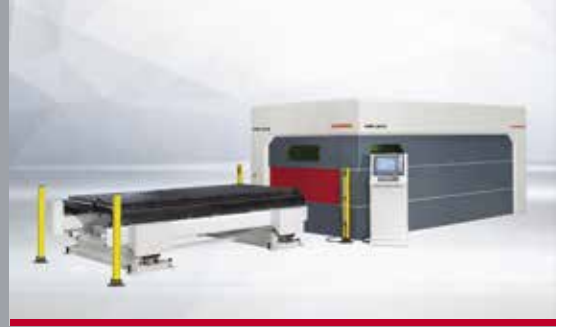

- Easy to Use
- High Quality Cutting
- Low Energy Consumption
- Faster
- Efficient
- Winning
- Ergonomic



**DURMA** The Winning Force





As a total supplier for sheet metal manufacturing with almost 60 years of experience, Durma understands and recognizes the challenges, requirements and expectations of the industry. We strive to satisfy the ever higher demands of our customers by continuously improving our products and processes while researching and implementing the latest technologies.

In our three production plants with a total of 150.000 m<sup>2</sup>, we dedicate 1,000 employees to delivering high quality manufacturing solutions at the best performance-to-price ratio in the market.

From the innovations developed at our Research & Development Center to the technical support given by our worldwide distributors, we all have one common mission: to be your preferred partner.

Present Durmazlar machines with **DURMA** name to the world.



1  
High technology,  
modern production  
lines



3  
High quality  
machines designed  
in R&D Centre

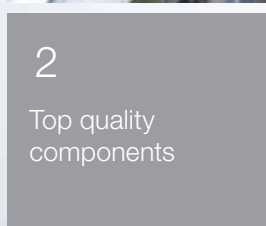

2  
Top quality  
components

# The Winning Force

Low operating cost and energy consumption

Globally recognized high performance components

Precise cuts and high durability

High profit margin





# Fiber Lasers provide innovative solutions

Perfect results on variety of material

Efficient and precise cuts on thick and thin material

Low investment and operating costs

Modern and compact design

Fast service with remote control



# Fiber Laser Technologies

Fiber lasers outshine with its fast cutting and energy efficiency abilities when especially its compared to CO<sub>2</sub> lasers. Easy use, maintenance and service has been achieved by the high technology of Fiber Lasers. Globally recognized efficient components used in **DURMA** Fiber Lasers add value to your company.

Rack & Pinion and Linear Motor Motion technologies allows us achieve 3G acceleration. We always strive to serve quality, performance and efficiency to our clients.

**DURMA** Fiber Laser is unrivaled with its rigid body structure, perfect filtration system, compact design, efficiency and user friendliness.

## Rack and Pinion Motion System (HD-F Series)

Axes motion is achieved by rack and pinion design. There are not any intermediate load transmitting elements between the motor and the pinion which otherwise could cause precision losses. High precision two-day, hardened helical racks with low clearance make it possible to achieve very high acceleration (synchronized 28 m/ s<sup>2</sup>.), speed (synchronized 170 m/min.) and accuracy (0,05 mm) values.



## Linear Motor Motion System (HD-FL Series)

Moving axes are driven by high velocity and acceleration linear motors which are the latest development in linear technology. These motors make it possible to achieve very high acceleration (synchronized 35 m/ s<sup>2</sup>.), speed (synchronized 280 m/min.) and accuracy (0,03 mm) values.

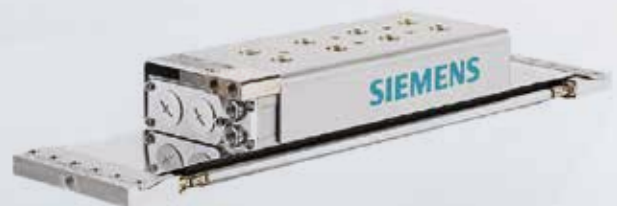

# Fiber Laser Power Source

Resonator	2.0 kW	4.0 kW	6.0 kW	8.0 kW	10.0 kW	12 kW	15 kW
Product designation	YLS-2000	YLS-4000	YLS-6000	YLS-8000	YLS-10000	YLS-12000	YLS-15000
Available operation modes	CW, QCW, SM						
Polarization	Random						
Available output power	200-2000 w	400-4000 w	600-6000 w	800-8000 w	1000-10000 w	1200-12000 w	1500-15000 w
Emission wavelength	1070 -1080nm						
Feed fiber diameter	Available in single mode, 50, 100, 200, 300µm						
Ancillary Options	Options Available: Internal coupler, Internal 1x2 beam switch, Internal 50:50 beam splitter, External 1x4 or 1x6 beam switch						
Interface	Standard: LaserNet, Digital I/O, Analog Control Additional Options: DeviceNet or Profibus						

Material (Cutting Capacity)	YLS 2000 (2kW)	YLS 4000 (4kW)	YLS 6000 (6kW)	YLS 8000 (8kW)	YLS 10000 (10kW)	YLS 12000 (12kW)	YLS 15000 (15kW)
Mildsteel (s235jr)	12 (16) mm	20 (22) mm	25 mm	25 (30) mm	30 mm	35 mm	35 (40) mm
Stainless Steel (1.4301)	6 (8) mm	10 (12) mm	15 (20) mm	20 (25) mm	25 (30) mm	30 (35) mm	35 (40) mm
Aluminum (AlMg3)	6 (8) mm	12 (15) mm	20 (25) mm	25 (30) mm	25 (30) mm	30 (35) mm	35 (40) mm
Copper	3 mm	6 mm	10 mm	12 mm	15 mm	15 mm	15 mm
Brass	6 mm	10 mm	12 mm	15 mm	20 mm	20 mm	20 mm

\*Standard cutting parameters.

Factors such as rust, shell formation, paint, label, pitch shifts on the surface, rolling defects, rusts on the surface of the material, affect the black sheet cutting negatively. The top and bottom surfaces of the material to be cut must be clean. The cutting quality and cutting speeds of sandblasted sheets vary.

## Low Operating Costs

- Low energy consumption
- Low cost per component
- Optimised focal distance for all thickness values
- Maintenance free operation
- Compact design, fast installation
- Rigid body structure, high durability

# Laser Cutting Head

The ProCutter offers a complete solution for the laser-based fusion cutting of thin and medium material thickness in the wavelength range around 1µm. In flame cutting, greater material thicknesses can also be processed while maintaining high standards of quality. The potential of the cutting head is optimally converted into productivity, especially in the case of flatbed and pipe cutting machines, where innovative technologies are combined with proven concepts, providing the best possible performance, range of flexibility and degree of reliability.

The combination of proven technology and optimized design enables processing with up to 10 kW laser power in the near-infrared range - and gives you reduced installation space and weight at the same time. A robust and dustproof housing ensures a long service life and allows external linear drive accelerations up to 4.5 g enabling an efficient cutting operation. High-quality optics and the highest standards of quality in manufacturing and assembly ensure optimum laser beam guidance and shaping with high focal position stability, even at high laser power.

## Efficient

- Lightweight and slim design created for fast acceleration and cutting speed
- Motorized focus position adjustment for automatic machine setup and piercing work
- Drift-free, fast-reacting distance measurement
- Permanent protective window monitoring
- Values displayed via bluetooth

## Flexible

- Selectable optical configuration, optimized for the range of applications
- Straight and angled design versions adapted to the machine concept
- Zoom lens for automatically adjusting the focus diameter
- Motorized or manual focal position adjustment

## User Friendly & Safe

- Completely dustproof beam path with protective windows
- LED operating status display
- Display of operating parameters via Bluetooth® and interface for machine control
- Pressure monitoring in the nozzle area (gas cutting) and in the head
- Monitoring of the piercing process and detection of cutting breaks with CutMonitor



App for iOS and Android gadgets



Dynamic laser cutting machines require smart cutting heads for its operations. ProCutter offers a fully-integrated sensor system that monitors the cutting process and provides the relevant information to the user. The ProCutter ensures that each component can be re-manufactured at a high standard of quality.



**Focal Length Adjustment:**  
Manual or motorized via machine control

**External Interface:**  
Output of all sensor data as an analog value, readout the values via Bluetooth®, set of thresholds



**Focusing Lens:**  
High-quality optics | X/Y adjustment | no repositioning | additional protective glass below focusing lens

**Protective Glass of Collimation Unit**



**Protective Glass Cartridge:**  
Protecting the optics against dirt and fume | monitoring of vattendance and contamination | tool free, easy change

**CutMonitor:**  
Monitoring of piercing process and detection of cut interruption



**LED Bar:**  
For immediate display of the current system state (pressure, temprature, drive, contamination)



**Mounting of the head:**  
Easy accessibility from the front



**Distance Measurement:**  
Fas, exact, drift-free distance measurement ay any operating temperatures, even at high accelarations



### Higher Acceleration on Z-Axis

Lighter and strongly rigid bridge does not allow it to vibrate at high speed and obtain high accurate cutting geometry.

Equipped with world's favorite head "Precitec". During the construction of the bridge all kind of deformations analyzed and prevented.



### Shuttle Table

Servo controlled shuttle table system applied to HD-F 3015 (Standard) and HD-F 4020 (Option) series machines reduces the changeover times by 40%. For 3015 series it drops down to 19 sec. and for 4020 series, to 29 sec.

The shuttle table is fully automatic and maintenance-free on all machines. Hydraulic oil is not used and changing the table is fast, soft and has low energy cost.

Table change time is 40 seconds in HD-F 4020 series. and 45 seconds in the HD-F 6020 series. Back and forth movement of all tables are performed with servo motors.



With Servo Motor : Standard HD-F 3015, Option HD-F 4020



With Asynchronous Motor : Standard HD-F 4020 - 6020

### Multi Chambers High Efficient Suction System

With the multi chambers high efficient system offers the ability to make an equal amount of suction during the cutting operation of the whole machine cutting area.

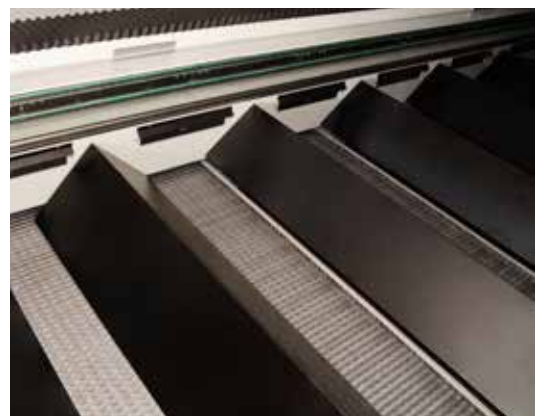

## Easy Access Side Door

There is standart side door to access the back part of the cutting sheet and correct the cutting parts positions during the operation. This side door also used by the service team of the laser machine when the maintenance will be done.



## Scrap Conveyor

The optional lateral automatic scrap conveyors allow the removal of scrap pieces from the working area without the need to interrupt the cutting process. The sideways operation of the short conveyors allow for easy maintenance and trouble-free running.



## Bevel Head $\pm 45^\circ$

Bevel Head for vertical and bevel cuts from  $0^\circ$  to  $45^\circ$ . Optimal results provided through the combination of 5 axis interpolation and software. Positive and negative bevel angles in one part.

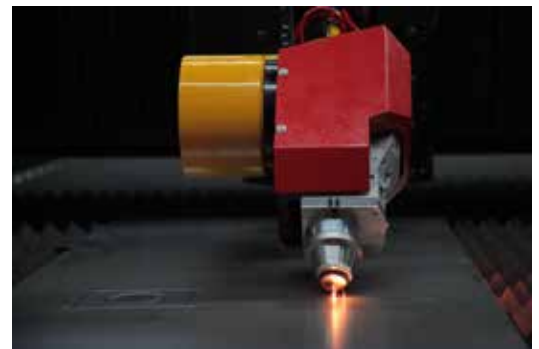

# Control Panel

The controller has a Durma operator interface and a complete cutting database for all standard cutting applications. The database includes the cutting parameters for standard materials (steel, stainless steel, aluminum) for common thickness ranges. Based on these reference values the operator can easily improve the cutting quality for different types of materials.

- Sinumerik 840 D SL
- IFP1900 19" Touch Screen
- IPC427 E Intel i5-6442EQ
- 8GB SD Ram DDR3WIN10/SSD 240 GB
- Ethernetx3
- USBx4
- PCI x1
- CF Card
- DPP



## Durma Cloud

Actual state of machine can be traced,  
 Operator can leave machine when program is too long  
 Cutted parts can be reported,  
 Retrospective or periodic reports can be created,  
 Cost calculations can be done,  
 Consumption calculations can be done,  
 Running duration, standby duration, productivity calculations can be done,  
 Error messages and error reasons can be inspected



## CAD/CAM Software

Lantek - Metalix

- Advanced optimisation: tools optimisation
- Fast tool way collision protection. Toolway optimisation to prevent damage from possible deformed material
- Writings supported by your operating system can be applied directly on the material to be cut
- Cutting direction, clockwise or opposite is supported
- Advanced corner applications provide perfect corners and soft cutting.
- Fillets, cooling, slowing down, circulation
- Shared Cuttings: This function is especially useful for thick plates and reduces the need of marking holes during cutting
- Automatic entry point
- Fully automatic cutting
- Z-Axis control



Lantek



Metalix



Lantek inside



Metalix  
MT software

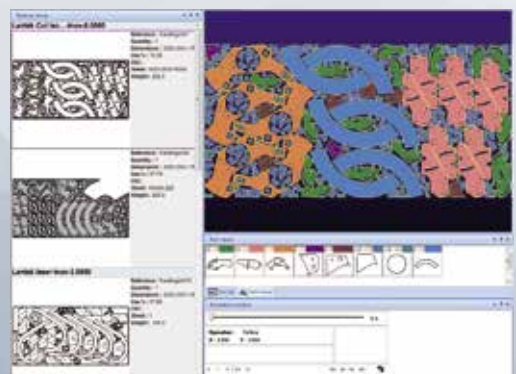



# Experience The Difference of DURMA HD-FL

## Chiller

*DURMA* Laser power source and cutting head is chilled with specially designed, low energy consuming, high efficient chiller unit.

## Filter

Used to eliminate dust, particles and harmful fumes, generated during cutting. It is fully automatic dust collecting shake filter.

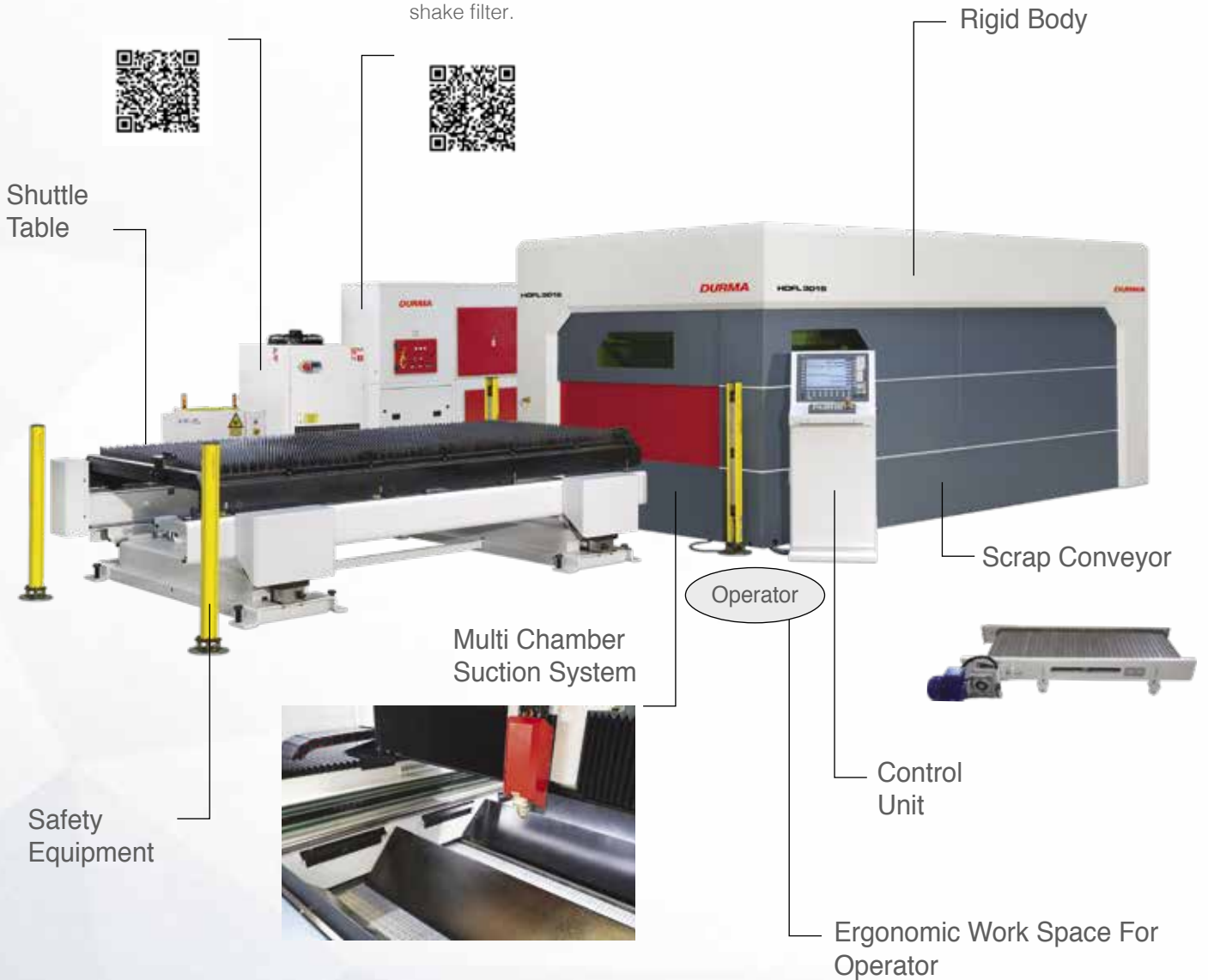



# HD-F / HD-FL

## FIBER LASER

	3015	4020	6020	8020	12020	
X Axis	3060	4100	6150	8200	12200	mm
Y Axis	1530	2100	2100	2100	2100	mm
Z Axis	160	185	185	185	185	mm
Max. Sheet Size	3048 x 1524	4064x2032	6096x2032	8128x2032	12192x2032	mm
Max. Sheet Weight	235	235	235	235	235	Kg/m <sup>2</sup>
	Rack&Pinion HD-F		Lineer System HD-FL			
X Axis	120		160		m/min.	
Y Axis	120		160		m/min.	
Synchronous	170		226		m/min.	
Acceleration	28		35		m/s <sup>2</sup>	
Positional Accuracy	±0,05		±0,03		mm	
Repeatability	±0,05		±0,03		mm	



**User  
Friendly**

**Ergonomic**

**Efficient**

**Fast**

**Reliable  
Brand**



# HD-FS FIBER LASER

	HDFS 3015	
X Axis	3100	mm
Y Axis	1550	mm
Z Axis	125	mm
Max. Sheet Size	3048x1524	mm
Max. Sheet Weight	200	Kg/m <sup>2</sup>
	Rack&Pinion	
X Axis	120	m/min.
Y Axis	120	m/min.
Synchronous	170	m/min.
Acceleration	16	m/s <sup>2</sup>
Positional Accuracy	±0,05	mm
Repeatability	±0,05	mm



# Why HD-FS Smart?

HD-FS Smart lasers are designed like HD-F series using same components. It is specifically designed for businesses that care about floor space. Loading and Unloading requires less effort in situations where shuttle table is not necessary.

HD-FS Smart Fiber Lasers make differences with speed, high quality components, efficiency and industrial design.

**User  
Friendly**

**Ergonomic**

**Efficient**

**Fast**

**Reliable  
Brand**



# HD-F / HD-FL BH

Pipe and Profile Cutting



Pipe and tube profile rotation system  
Pipe diameter capacity of  $\text{Ø}30$  up to  $\text{Ø}400$   
Square profile capacity of  $250 \times 250$   
Fume extraction connection  
Adjustable support units for pipe and tube profile

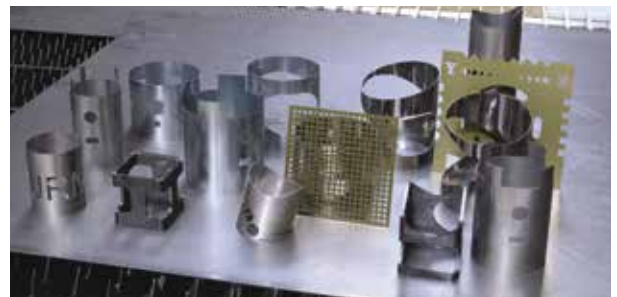

Shapely pipe cutting  
Shapely cutting on all faces of tube profile.





# HD-F / HD-FL BH

Tube – Profile Cutting Technical Features		
Cutting length	mm	3.000 mm (Chuck 6.000 mm through)
Maximum tube loading	Kg	120
Laser power supply		1-10 kW
Working diameter	in./max.	Ø30 / Ø400
Max. tube thickness	mm	Up to 12 mm depending on material and laser power
Square profile cutting	Max.	250 x 250 mm
Max. positioning speed X / Y	m/min.	100
Positioning accuracy	mm	+/- 0,5 / 1000
Repeatability	mm	+/- 0.1
Materials		Mildsteel / Stainless / Aluminum / Copper / Brass
Cutting head	-	Precitec
Dust extraction and filter	-	Available
Axis motors	-	Siemens
Electrical equipment	-	Siemens or Telemecanique
CNC control	-	Sinumerik 840 D SL
Software	-	Lantek Flex3D Tube
Network card	-	Optional

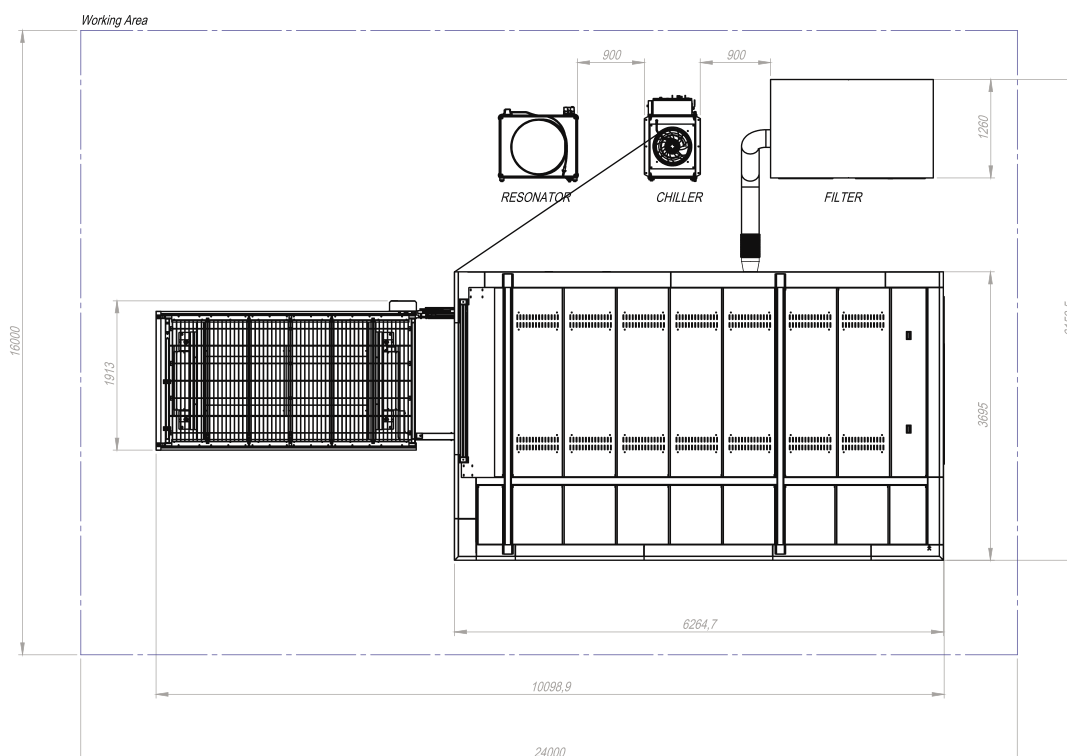

# HD-FO FIBER LASER



**User  
Friendly**

**Ergonomic**

**Efficient**

**Fast**

**Reliable  
Brand**



# SPECIFICALLY DESIGNED ACCORDING TO LAYOUT

HDFO fiber lasers, stand out with their speed, high quality materials, efficiency and industrial design. The loading and unloading of the material to be cut requires less effort when the shuttle table is not required.

- User Friendly
- Low Running Costs
- Quick Opening Front Door
- Easy Access To Cutting Area Compact
- Bridge Design
- Fast Packing & Delivery

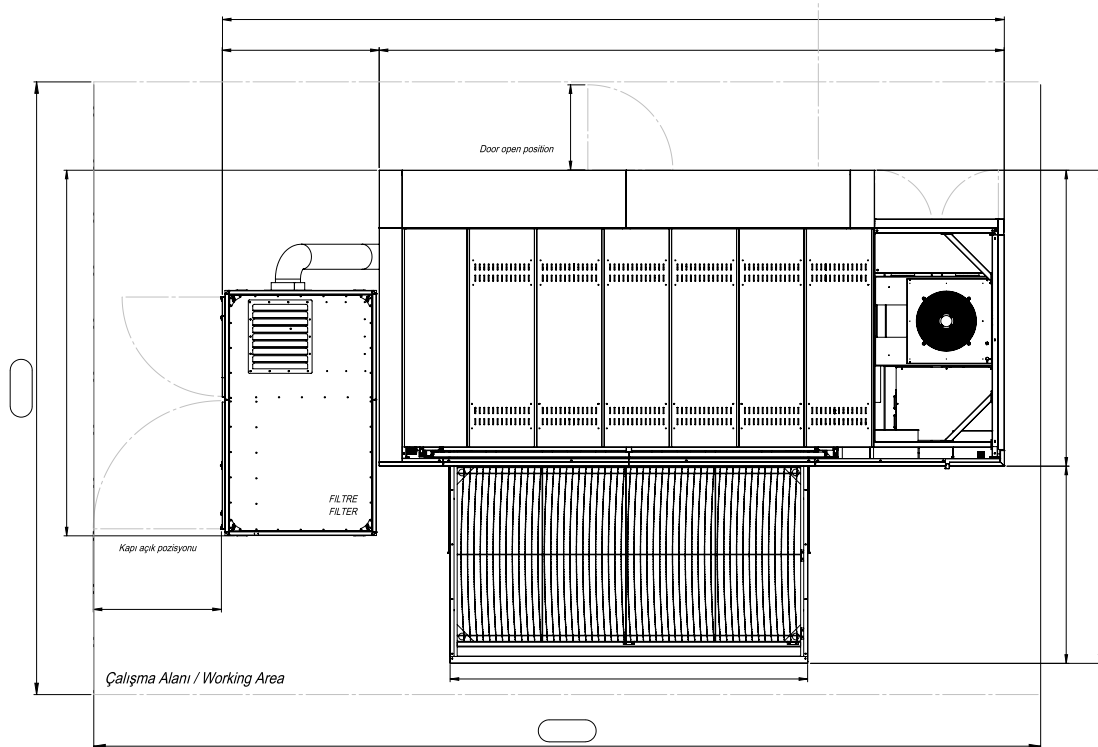
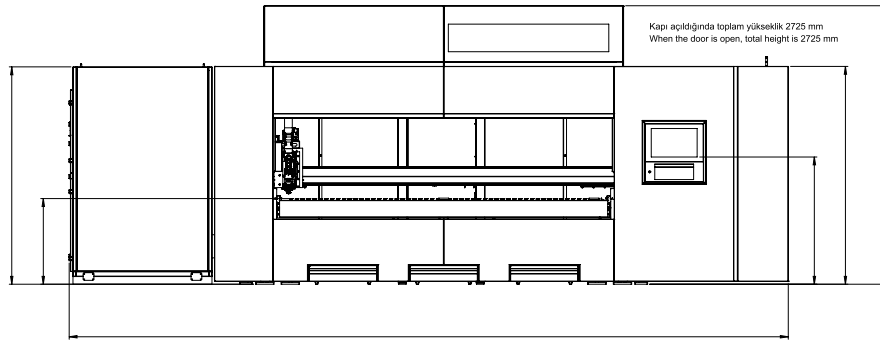

# HD-FO

## FIBER LASER

HD-FO Technical Data				
<b>Cutting axes</b>				
X Axes	3048			mm
Y Axes	1530			mm
Z Axes	125			mm
Max. Sheet Dimensions	3.048 x 1.524			mm
Max. Sheet Weight	575			kg
<b>Dynamics</b>				
Max. Speed X Axis	90			m/min.
Max. Speed Y Axis	90			m/min.
Max. Speed Z Axis	30			m/min.
Max. Synchronized Hz (X-Y)	127			m/min.
Max. Synchronized Acceleration	14			m/s <sup>2</sup>
Positioning Tolerance	± 0,05			mm
Repeatability	± 0,05			mm
<b>Control Unit</b>				
CNC	SIEMENS SINUMERIK 840D SL			
Screen	19" Touch Screen			
<b>Laser Cutting Head</b>				
Type	Precitec Lightcutter / DURMA			
Focal Distance (mm)	150			
Focal Type	Auto			
<b>Material Cutting Thickness (mm)</b>				
Material	YLR 1000 (1kW)	YLS 2000 (2kW)	YLR 3000 (3kW)	YLS 4000 (4kW)
Mild Steel	8	12	16	20
Stainless Steel	4	6	8	10
Aluminium (AlMg3)	4	6	8	12
Copper	2	3	5	6
Brass	4	6	8	10



## MANUAL CUTTING TABLE

The machine is designed especially for the customers who has layout problems. Sheet loading and unloading is extremely easy in cases where no shuttle table is needed.



## COMPACT, MODERN AND ERGONOMIC LAY-OUT

Helping of the compact layout of the machine, sheet loading, cutting and unloading operations are performed by using less space and less operations

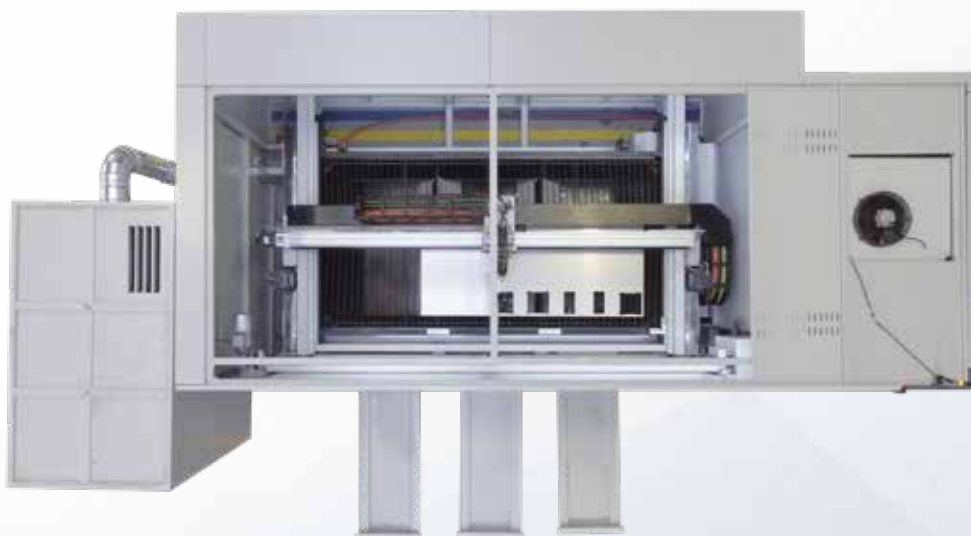

## PNEUMATIC SHUTTLE TABLE (OPTION)

As standard there is a manual cutting table. Optionally, with your 1 or 2 KW power source order, you can get a pneumatic shuttle table.

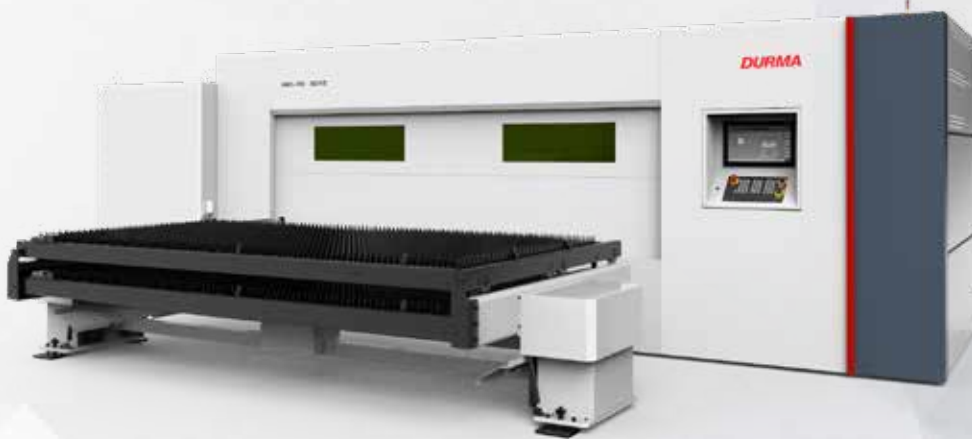

## EASY ACCES TO CUTTING AREA WITH BACK DOOR

Rear door for use when cutting is required.  
This rear door is also used during machine maintenance



# HD-FA

5 AXIS LASER



**User  
Friendly**

**Ergonomic**

**Efficient**

**Fast**

**Reliable  
Brand**



HD-FA 301B



# THE 5 AXIS FIBER LASER SYSTEM FOR AUTOMOTIVE AND AEROSPACE INDUSTRY

DURMA 5 axis fiber laser system will be your best partner for automotive and any other high-sense and 3D complex part production. +25% increased processing space due to same concept machines. For gratify cutting performance, strong machine frame and rotary table provide best quality.

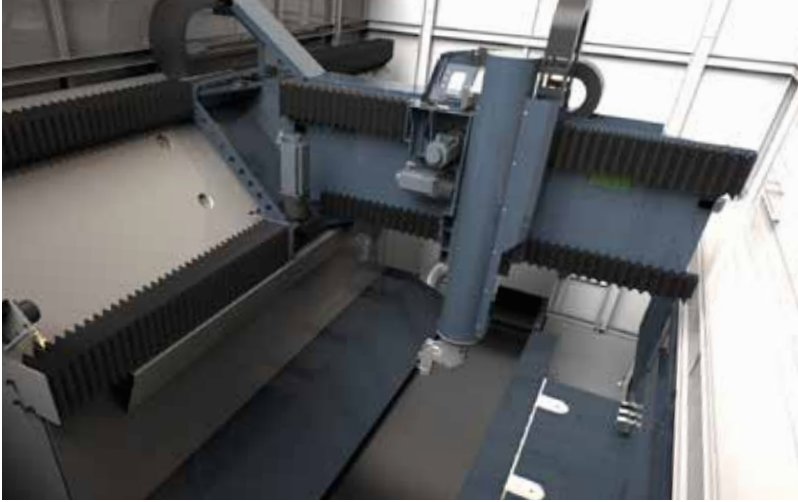

- Modern and Compact Design
- Easy to use Fixture
- Globally High Performance Components
- High Quality 3D Cutting
- Low Energy Consumption
- Faster, Reliable, Efficient

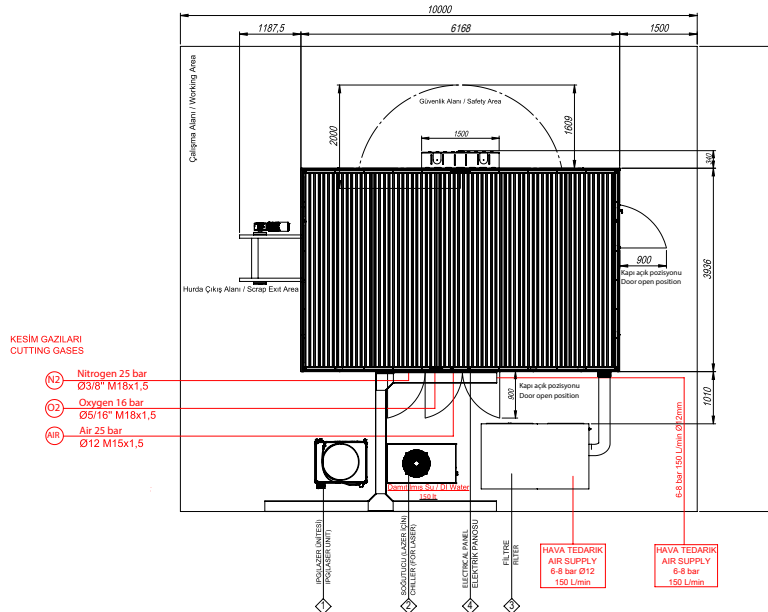
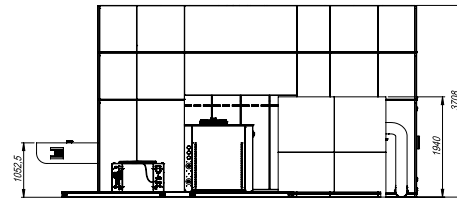



## HD-FA TECHNICAL SPECIFICATIONS

X axis stroke	3.000 mm
Y axis stroke	1.500 mm
Z axis stroke	650 mm
B axis	±135°
C axis	±360°xn
Max. Synchronous Speed	173 m/min.
Max. Synchronous Acceleration	1,73 G
Positional Accuracy	±0.08 mm
Repeatability	±0.08 mm

## MACHINE SIZES

Machine Size	6168 mm x 3936 mm h= 3700 mm
Working Area	9.000 mm x 10.000 mm (Secure area)
Rotary Table's Door Length	4.000 mm
Machine Weight	16.000 kg

## CUTTING THICKNESS mm

Power	2 kW	3 kW	4 kW
Mild Steel (mm)	12	16	20
Stainless (mm)	6	8	10
Aluminum (AlMg3) (mm)	6	8	12
Brass (mm)	6	8	10
Copper (mm)	3	5	6

## CUTTING HEAD

Type	3D
Focus	Automatic

## CONTROL UNIT

CNC	SIEMENS SINUMERIK 840D SL
Screen	19" Touch panel

## FILTER

Capacity	2.500 m <sup>3</sup> /h - 4 kW
----------	--------------------------------

## CHILLER

Chiller for 2 kW	IPG LG 71
Chiller for 3 kW	IPG LG 170
Chiller for 4 kW	IPG LG 171

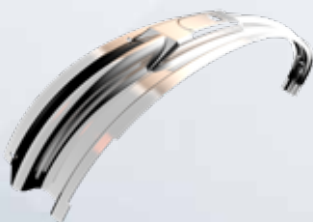

# SPECIAL APPLICATIONS

## Turkey's Biggest and Fastest Laser

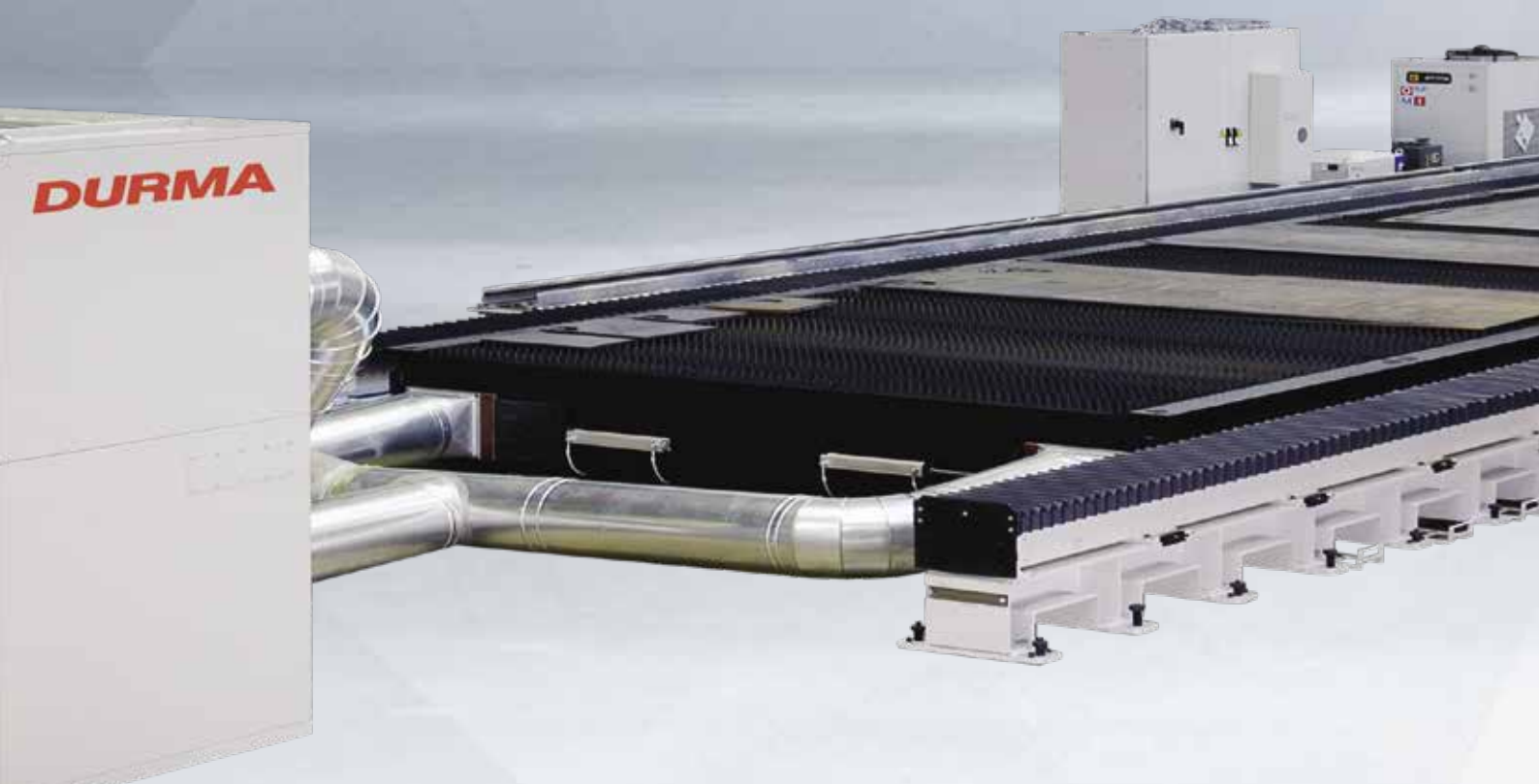

# HD-F 20030

Cutting Length	20.000 mm
Cutting Width	3.000 mm
Power Source	6 kW



# HD-F 20030

HD-F 20030 Technical Specifications

Y Axis maximum speed	100 m/min
U Axis maximum speed	15 m/min
X axis maximum speed	100 m/min
Y axis maximum acceleration	1 g
U axis maximum acceleration	0.1g
X axis maximum acceleration	1 g
Positioning accuracy 15 mt. x 3 mt.	0.05 mm/1.5m
Y axis moving bulk	50 kg.
U axis moving bulk	3500 kg.
X axis moving bulk	450 kg.

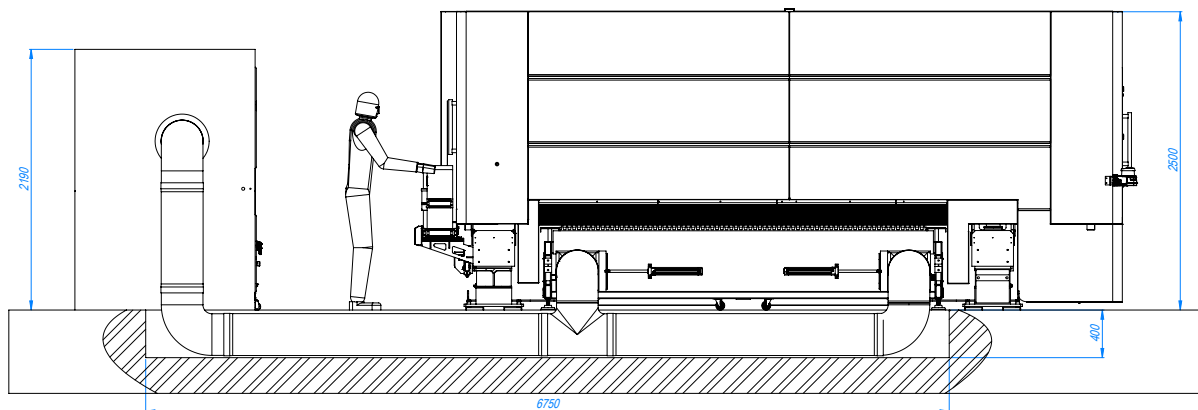

# Automatic Loading – Unloading Units Solutions For Your Job

Manual loading-unloading systems

Semi automatic loading-unloading systems

Automatic loading-unloading systems

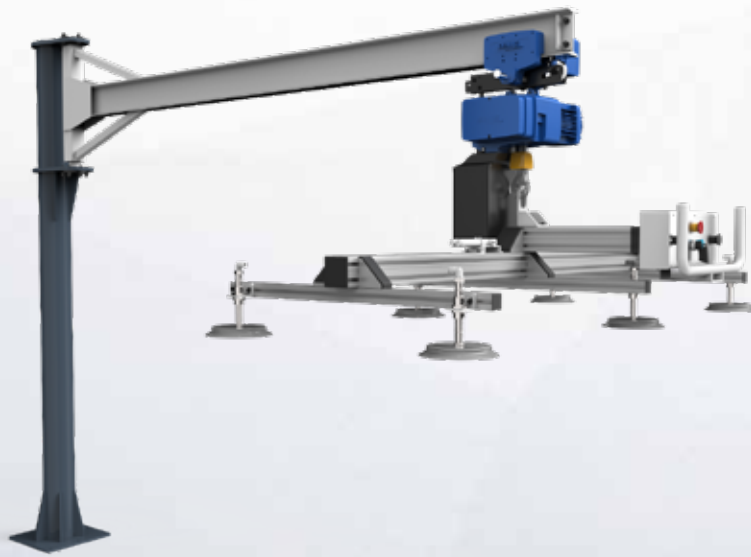

## M-LOADER 3015 / 4020

Technical Data	3015	4020
Sheet Length (Max.)	500 - 3.000 mm	500 - 4.000 mm
Sheet Width (Max.)	500 - 1.500 mm	500 - 2.000 mm
Sheet Thickness	10 mm	6 mm
Max. Loading Capacity	360 kg.	450 kg
Vacuum Pad Qty.	6 sec.	8 sec.
Rotation angle ( Max. )	260°	260°
CONSUMPTION VALUES		
Elektricity	0.5 kW	0.5 kW
Compressed Air	3 m³/h -- 7 bar	3m³/h -- 7 bar

### D-LOADER 3015 / 4020

Technical Data	3015	4020
Sheet Length (Max.)	500 - 3.000 mm	500 - 4.000 mm
Sheet Width (Max.)	500 - 1.500 mm	500 - 2.000 mm
Sheet Thickness	0,5 - 25 mm	0,5 - 25 mm
Max. Loading Capacity	900 kg.	1.600 kg
Vacuum Pad Qty.	12 pcs.	18 pcs.
Total Cycle Time	60-75 sec. (depends on loading height)	65-85 sec.(depends on loading height)
Working Area	4.200 x 4.100 mm h= 2.260 mm	5.500 x 5.400 mm h= 2.720 mm
Rotation angle ( Max. )	90°	90°
Elektricity	3 kW	4 kW
Compressed Air	6 m³/h--7 bar	10 m³/h--7 bar



### DURMA RAPID SERVER 3015 / 4020

Technical Specifications	3015	4020
Sheet Sizes	800 - 800 mm	1.000 - 1.000 mm
Length	1.000, 1.500, 2.000, 2.500, 3.000 mm	1.000, 1.500, 2.000, 2.500, 3.000, 3.500, 4.000 mm
Width	1.000, 1.250, 1.500 mm	1.000, 1.250, 1.500, 2.000 mm
Thickness	0,5 - 25 mm	0,5 - 25 mm
Max. Sheet Size	3.050 x 1.525 mm	4.064 x 2.032 mm
Max. Loadable Sheet Loading Weight	5.000 kg	6.000 kg
Max. Sheet Loading Height	250 mm	230 mm
Cycle Time	50 sec.	60 sec.
Workspace	6.950 x 5.200 mm h= 3.400 mm	18.500 mm h=3.600 mm
Dual Sheet Sensor	Yes	Yes
Sheet Separation System	Yes	Yes



## DURMA RAPID TOWER 3015 / 4020

Technical Specifications	3015	4020
Sheet Sizes	800 - 800 mm	1.000 - 1.000 mm
Length	1.000, 1.500, 2.000, 2.500, 3.000 mm	1.000, 1.500, 2.000, 2.500, 3.000, 3.500, 4.000 mm
Width	1.000, 1.250, 1.500 mm	1.000, 1.250, 1.500, 2.000 mm
Thickness	0,5 - 25 mm	0,5 - 25 mm
Max. Sheet Size	3.050 x 1.525 mm	4.064 x 2.032 mm
Max. Sheet Metal Loading Weight That Can Be Loaded On The Pallet	3.000 kg	4.000 kg
Pallet Numbers	10	10
Total Loadable Sheet Weight	30.000 kg	40.000 kg
Max. Sheet Loading Height	85 mm	85 mm
Cycle Time	50 sec.	60 sec.
Workspace	8.700 x 4.550 mm h=5.400 mm	11.200 x 6.150 mm h=5.600 mm
Dual Sheet Sensor	Yes	Yes
Sheet Separation System	Yes	Yes
Electric Power	23 kW	23 kW
Compressed Air	10 m³/h -- 7 bar	10 m³/h -- 7 bar





# SPECIAL APPLICATIONS



Endüstri Makineleri



Fason Sac Kesim Merkezleri



Damper Treyler



Aydınlatma ve Enerji Direkleri



# Fast on Service and Spare Parts

*DURMA* provides the best level of service and spare parts with qualified personnel and spare parts in stock. Our experienced and professional service personnel are always ready at your service. Our professional training and application enriched courses will give you an advantage to use our machinery.



Consultancy



Spare Parts



R&D Center



After Sales Service



Service Agreements



Software



Training



Flexible Solution

**DURMA**



PANEL BENDER



PUNCH



PLASMA



L ANGLE PROCESSING CENTER



IRON WORKER



POWER OPERATED SHEAR

**DURMA**

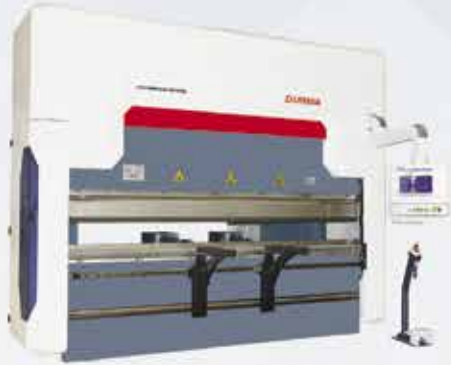

PRESS BRAKE



VARIABLE RAKE SHEAR



TUBE LASER CUTTING

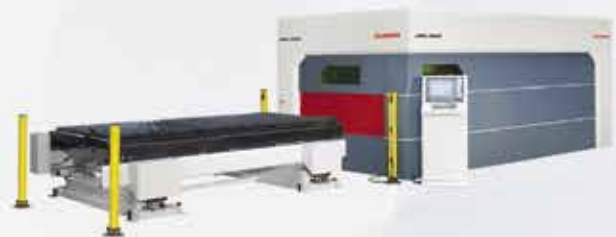

FIBER LASER

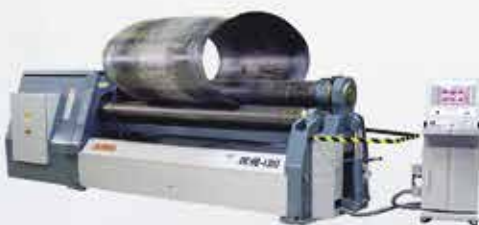

ROLL BENDING



PROFILE BENDING



CORNER NOTCHER

***DURMA***

**FIBER LASER**  
Technologies