

The Winning Force

DURMA

AD-SERVO SERIES

Press Brakes



- Perfect Precision
- Profit
- Energy Efficient
- Hi-Speed & Repeatability
- Elegant Design



DURMA The Winning Force



As a total supplier for sheet metal manufacturing with almost 60 years of experience, Durma understands and recognizes the challenges, requirements and expectations of the industry. We strive to satisfy the ever higher demands of our customers by continuously improving our products and processes while researching and implementing the latest technologies.

In our three production plants with a total of 150.000 m², we dedicate 1,000 employees to delivering high quality manufacturing solutions at the best performance-to-price ratio in the market.

From the innovations developed at our Research & Development Center to the technical support given by our worldwide distributors, we all have one common mission: to be your preferred partner.

Present Durmazlar machines with **DURMA** name to the world.



1
High technology,
modern production
lines



2
Top quality
components



3
High quality
machines designed
in R&D Centre

AD-Servo Series Press Brake

Now Production is More Effective

The future – as a result of rising energy costs and increasingly cost efficient speed-controlled drives offered on the market, variable-speed solutions are on the advance.

Cost Down Profit Up

Precise bending result at fast speed

Minimalized tool change and adjustment time

Maximized speed and safety

Energy-efficient Hydraulics with Variable Speed Pump Drives

Energy consumption has a significant effect on Total Cost of Ownership of plant and machinery: even with standard machines, the energy consumption represents 30% of total costs, and with particularly energy-intensive applications, this share is remarkably higher.

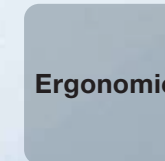
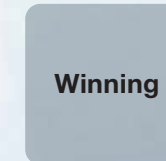
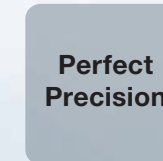
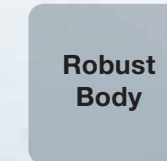

Advantages

- High energy-saving potential
- Decreased operating costs
- Clearly reduced cooling effort
- Operational reliability
- High availability
- Lower investment
- System safety
- Future-oriented technology
- Remarkable noise reduction
- Fewer secondary measures
- Ease of integration of flexible check functions
- Decrease in the number of expensive machine failures
- Compliance with EU Directives



Comparison of Energy Consumption of a Press Brakes

Electric Consumption

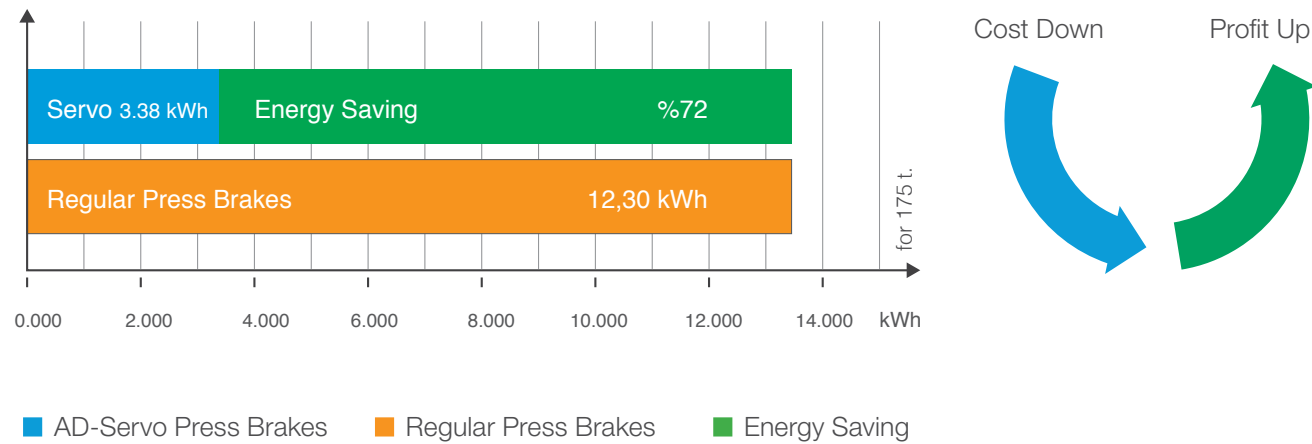

Main components

- Servomotor
- Hydromotor-pump (4-quadr. oper.)
- Servo controller IndraDrive C
- Software-Technology function
- Parameter
- Bell housing and coupling
- Power unit (Oil tank, accessories)
- Valve block, prefill valve
- Cylinder

Physical characteristics

- Control of position
- Control of pressure/load pressure
- Open/closed hydraulic circuit
- 4-quadrant operation

Productivity

%60 more productivity with %72 less energy consumption at work.

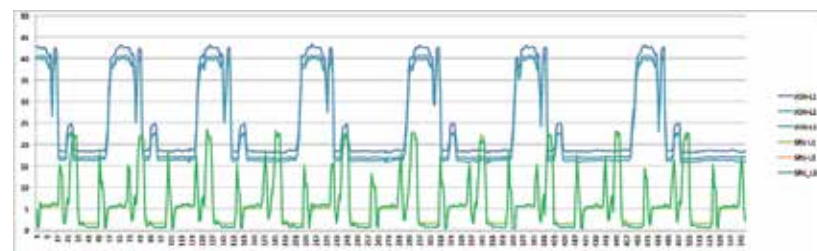

Less Noise Level

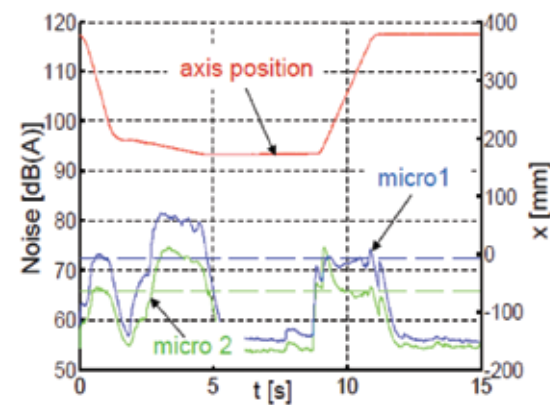

Fast Increase in Efficiency in Production

AD-Servo is high modularity of hydraulics also opens up economic options on existing plant and machinery by substituting fixed displacement power units by variable-speed pump drives with little effort.



- Energy Saver
- Accurate on each cycle
- Economy Proof
- Hi-Speed & Repeatability



Depending on cycle characteristics and rating, variable-speed pump drives achieve energy savings

AD-Servo positioning accuracy Less Noise Level at target position

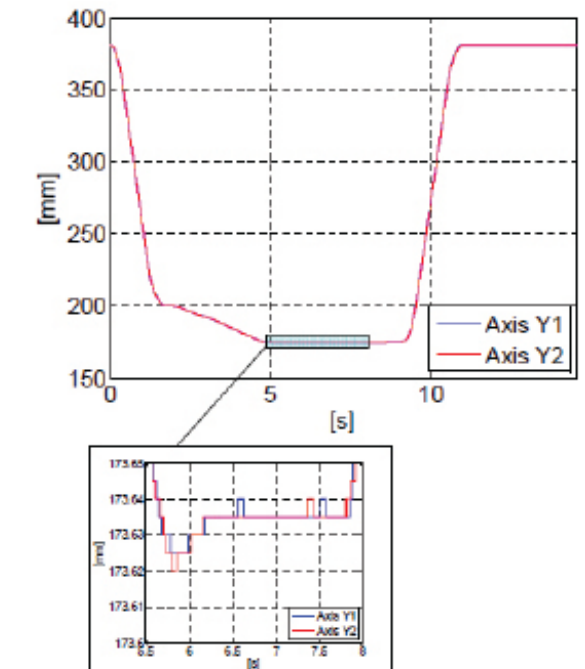

Fast, Efficient, Modern

AD-Servo Series press brakes, designed with high technology to increase efficiency on precise part bending.

Quality approved components used.
Stress relieved made on bodies for long life and precise bending.



General Specifications

- High sensitivity, Stress relieved steel construction body, long life Mono Block Frame
- Automatic calibration and first start up
- DURMA designed and copyrighted guiding system
- Ball Screw and linear guide integrated perfect back gauge system
- Durable, long life and sensitive bending capable special hardened top tools
- Suitable for segmented tools special and fast tool holding system
- Sensitive solutions on Long and deep bending
- High accuracy linear scales
- CE safety standards
- Best quality world wide accepted hydraulic and electric components

Strong Back Gauge System

- Precise
- Reliable
- Strong

- Fast and high accuracy
- Safe movement
- Resistance to crash
- Maintenance free
- Adjustment availability at every point

Why DURMA Back Gauge ?

Most important feature to achieve perfect bending is the stability and the design of the back gauge, which allows an impeccable and correct product to be produced.

The high speed **ballscrew** back gauge system movement is also supported with **linear guides**, which helps the back gauge achieve long life, greater sensitivity and strengthens against any collisions.

Special designed finger blocks with steps to achieve maximum stability can also be supplied for every kind of bending solution.

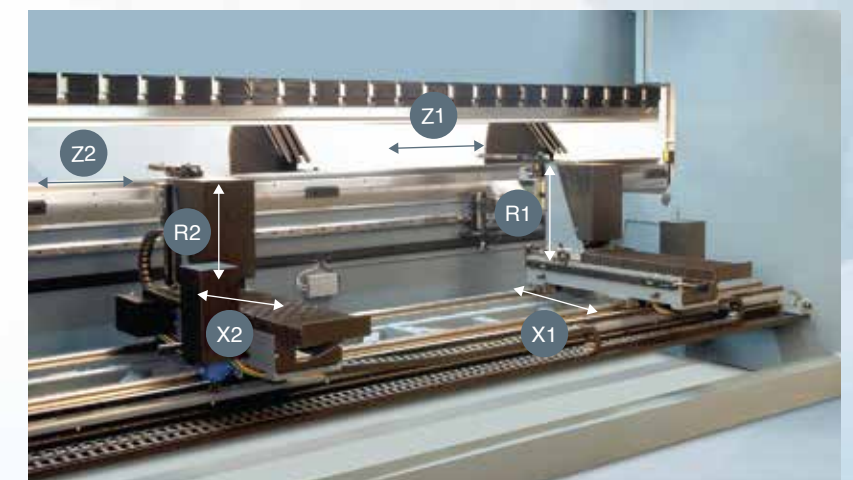
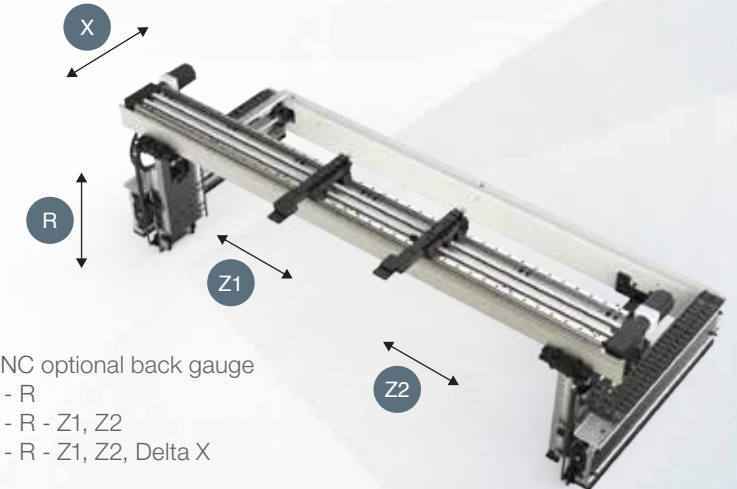

Tool Holders and Tools

Bending performance increased using with high quality European clamping system and easy to use. Narrow table designed for European style tool holder and Z bending.

DURMA is your solution partner with various tool options.



European Clamping System

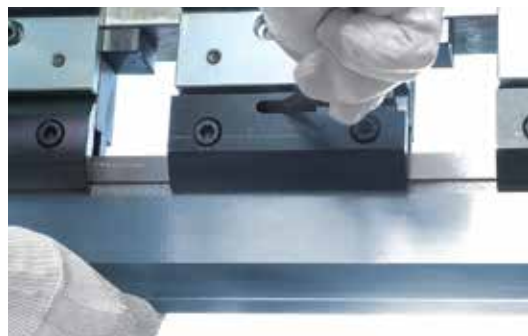

Quick Release Clamping



Wila Top Tool Clamping



DURMA Top Tool



European Type Bottom Tool (4V Die)



Wila Bottom Tool Clamping



DURMA Multi V Bottom Tool

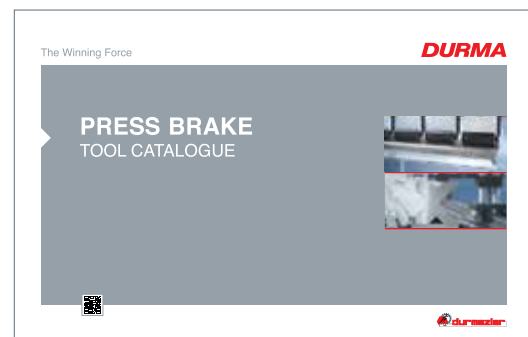

Safe and Accurate Bends with Top Quality Equipments

Crowning System

Manual or CNC-controlled motorized crowning system simplifies bending, by adjusting each point of the bending parts to acquire straight bends. The need for shimming is eliminated.



CNC Crowning System

Linear Guide Front Sheet Supports

Rugged support arms with tilting stops are mounted on a linear guide rail system. This allows "finger-tip" lateral adjustment as required by the bend length of the part. They are also equipped with side gauges for the fast, easy, and accurate feeding of parts small or large.



Linear Guide Front Sheet Supports

CE Safety Systems

Our machines are designed in accordance with CE-Norms to ensure your safety with hydraulic, electric, appropriate height covers and laser light curtains. CE safety in tandem machines are also provided with light barriers.



CE Laser Safety System

Stable Top Beam Movement

By using long and planar guiding surfaces, all the disadvantages of point guiding are eliminated 100% free bending space: guiding system that eliminates bending between frame has been moved to the outside of the frame.

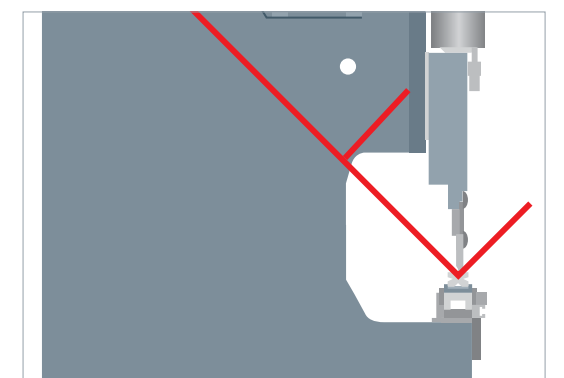

90 Degree Endless Bend

Now Bending is More Easier

ModEva 19T



- 19" color Touch Screen
- On-screen finger profile drawing
- Automatic bend listing
- Very simple and convenient data transfer
- Higher productivity thanks to easy and rapid
- Multi-simulation capability
- Simulation criteria for better sheet management
- Windows XPe for multitasking and file management
- EC safety-cycle management
- Ethernet for easy communication
- Bundled Offline Software

DA-66T



- 2D graphical touch screen programming mode
- 3D visualisation in simulation and production
- 17" high resolution colour TFT
- Full Windows application suite
- Delem modusys compatibility
- USB, peripheral interfacing
- User specific application support within the controllers multitasking environment
- Sensor bending & correction interface

System of DURMA Angle Measurement



Automotic AP3 - AP4 Sheet Follower

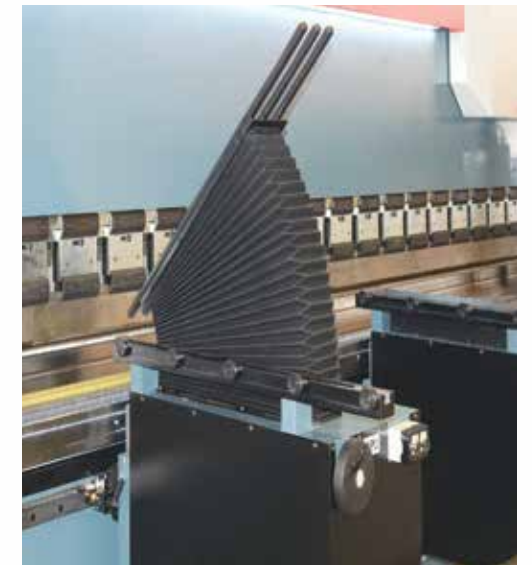

Robotic System of Applications

Modeva Premium

- Full 3D simulation
- Multiple view points while working
- 3D collision detection
- User defined table for bend deduction
- Rapid solution computation
- Importing 3D models (MetaBEND, IGES)
- Automatic Tool Shape Selection
- Video-like bend simulation.
- Almost unlimited quantity of programs and sequences

DA-69T

- Higher grade of efficiency
- 3D and 2D graphical touch screen programming mode
- 17" high resolution colour TFT
- Minimal set up time
- Delem modusys compatability
- Sensor bending correction interface
- 1 GB memory capacity
- Integrated OEM-Panel
- 1280x1024 pixels, 16-bit colour
- 3D graphics acceleration



Standard & Optional Equipment

Standard Equipment

Y1, Y2, X, R - 4- Axis
 Control Unit - CNC ModEva19T
 CE Manuel F. AKAS II M FPSC-B-C + Safety Cages with switch
 CE F.AKAS BVLTLight barrier and safety cages (for tandem Press Brakes)
 Servo motor back gauge & linear guided & ballscrew system (X-R)
 CNC controlled motorized Crowning
 European style tool clamping system
 Sliding front arms (With T-Slot and stopper)
 World standards special design hydraulic block and valves
 World standard electric equipment

Optional Equipment

Control Unit - ModEva Premium, 69T ve 66T
 Motorized FIESSLER AKAS-3PM (distance of mute until 3 mm)
 Z1, Z2 Axis
 X1, X2 Axis
 R1, R2 Axes
 Delta X Axis ± 125 stroke
 X Axis = 1000 mm – light barrier back protection
 AP3-AP4 Automatic system of sheet follower – Motorized elevation adjustment
 (There is a motorized elevation adjustment of 220 tons or more.)
 System of laser angle measurement
 Quick release clamping system
 Hydraulic and pneumatic tool clamping systems
 Bottom and top tools
 Bottom tool separation system
 Parking area
 Central lubrication system
 Oil cooler
 Additional back gauge finger and sliding front support arms
 Special packing for overseas shipments
 DBEND 3D bending simulation program

Fast on Service and Spare Parts

DURMA provides the best level of service and spare parts with qualified personnel and spare parts in stock. Our experienced and professional service personnel are always ready at your service. Our professional training and application enriched courses will give you an advantage to use our machinery.



Consultancy



Spare Parts



R&D Center



After Sales Service



Service Agreements



Software



Training



Flexible Solution

AD-Servo Series Technical Details

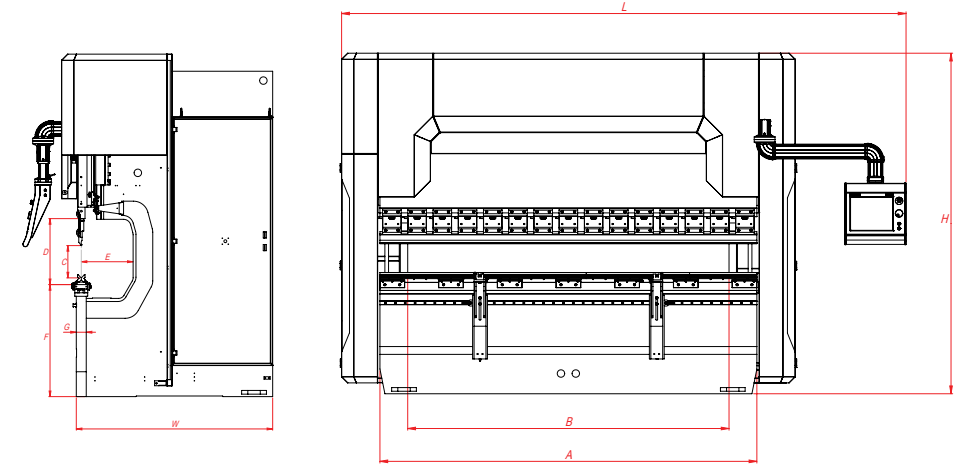

AD-SERVO Series	Bending Force	Bending Length	Distance Between Columns		Stroke	Daylight	Throat Depth	Table Height	Table Width	Y Rapid Speed	Y Working Speed	Y Return Speed	Y Axes Precision	X Axes Working Speed	X Axes Precision	X Axes Dimensions			R Axes Working Speed	R Axes Working Distance	R Axes Precision	Z Axes Working Speed	Z Axes Working Distance	Motor Power	Consumption Ratio	Oil Tank Capacity	Length	Width	Height	Weight Approx.
			mm	mm												25,6	29,5	39,4												
			mm/s	mm/s												mm/s	mm	mm												
	A	B	C	D	E	F	G																							
AD-Servo 25100	100	2550	2200	265	530	450	900	104	200	10	200	0,01	500	0,05	S	-	O	350	250	0,1	1000	1580	4 x 2	2,1	75	3800	1670	2850	7800	
AD-Servo 30100	100	3050	2600	265	530	450	900	104	200	10	200	0,01	500	0,05	S	-	O	350	250	0,1	1000	1990	4 x 2	2,1	75	4200	1670	2850	8500	
AD-Servo 30135	135	3050	2600	265	530	450	900	104	200	10	200	0,01	500	0,05	S	-	O	350	250	0,1	1000	1990	4 x 2	2,65	75	4200	1680	2850	9580	
AD-Servo 30175	175	3050	2600	265	530	450	900	104/180	200	10	200	0,01	500	0,05	S	-	O	350	250	0,1	1000	1990	4 x 2	3,38	75	4250	1700	2850	10900	
AD-Servo 30220	220	3050	2600	265	530	450	900	104/180	200	12	180	0,01	500	0,05	S	-	O	350	250	0,1	1000	1990	11 x 2	5,2	80 x 2	4250	1770	3000	12600	
AD-Servo 30320	320	3050	2600	365	630	450	900	104/240	160	10	160	0,01	500	0,05	S	-	O	350	250	0,1	1000	1990	11 x 2	7,2	80 x 2	4300	1820	3330	17100	
AD-Servo 37175	175	3700	3100	265	530	450	900	104/240	200	10	200	0,01	500	0,05	S	-	O	350	250	0,1	1000	2375	4 x 2	3,38	75	4950	1700	3000	11750	
AD-Servo 37220	220	3700	3100	265	530	450	900	104/240	200	12	180	0,01	500	0,05	S	-	O	350	250	0,1	1000	2375	11 x 2	5,2	80 x 2	4950	1770	3000	14440	
AD-Servo 40175	175	4050	3600	265	530	450	900	104/240	200	10	200	0,01	500	0,05	S	-	O	350	250	0,1	1000	2910	4 x 2	3,38	75	5250	1700	2850	12780	
AD-Servo 40220	220	4050	3600	265	530	450	900	104/240	200	12	180	0,01	500	0,05	S	-	O	350	250	0,1	1000	2910	11 x 2	5,2	80 x 2	5250	1770	3000	14750	
AD-Servo 40320	320	4050	3600	365	630	450	900	154/300	160	10	160	0,01	500	0,05	S	-	O	350	250	0,1	1000	2910	11 x 2	7,2	80 x 2	5300	1910	3330	20000	
AD-Servo 60220	220	6050	5100	265	530	450	1050	104/240	200	12	180	0,01	500	0,05	-	S	O	350	250	0,1	1000	4400	11 x 2	5,2	80 x 2	7500	1770	3350	20800	
AD-Servo 60320	320	6050	5100	365	630	450	1100	154/300	160	10	160	0,01	500	0,05	-	S	O	350	250	0,1	1000	4400	11 x 2	7,2	80 x 2	7500	1910	3350	29000	

* 750 mm throat depth
 ** 750 - 1000 - 1250 mm throat depth
 Machines set according to optimum values.

DURMA

DURMA



PANEL BENDER



PUNCH



PRESS BRAKE



VARIABLE RAKE SHEAR



PLASMA



L ANGLE PROCESSING CENTER



TUBE LASER CUTTING

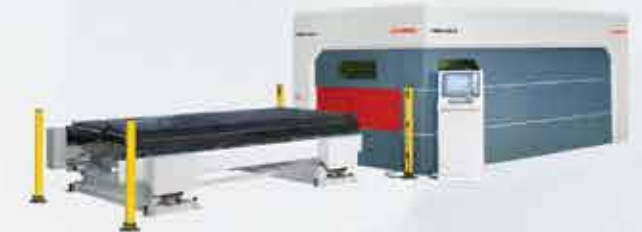

FIBER LASER



IRON WORKER



POWER OPERATED SHEAR



ROLL BENDING



PROFILE BENDING



CORNER NOTCHER

DURMA

Today, Tomorrow, Forever...

V	b	r _i	s(mm)																					
			0.5	0.8	1	1.2	1.5	1.8	2	2.5	3	3.5	4	4.5	5	6	7	8	9	10	12	15	18	20
6	5	1	2,5	6,5	10																			
8	6	1,3	2	5	8	11																		
10	7	1,7	1,5	4	6	9	13																	
12	9	2		3	5	7	11	16																
15	12	2,7			4	6	9	13	16															
20	15	3,3				4	7	10	12	19														
26	18	4,2					4	7,5	9	14	21													
30	22	5						6,5	8	12	19	24												
32	23	5,4						7,5	11,6	17	23	30												
37	25	5,8							10	14,5	20	26	33											
42	29	6,7								13	17	23	29	33,5										
45	32	7,5									16	21	27	33	48									
50	36	8,3										19	24	30	43	58								
60	43	10											20	25	36	49	64							
70	50	11,5												21	31	42	55	69						
80	57	13,5													27	37	48	60	75					
90	64	15														32	42	54	66	95				
100	71	17															38	48	60	86	134			
130	93	22																	37	46	66	103	149	
180	130	30																		33	48	75	107	153
200	145	33																			43	67	83	119
250	180	42																				54	77	92

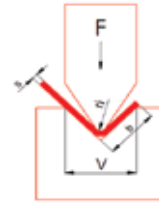

$$F = \frac{1,42 \times L \times Rm \times s^3}{1000 \times V} \text{ (Ton)}$$

F: Bending Force (Ton) L: Length (mm) Ri: Inside Radius (mm) Rm: Material Tensile Strength (daN/mm²) V: Channel Width (mm) B: Minimum Sheet Bending Side (mm) S: Thickness (mm)

AD-SERVO SERIES Press Brakes

Durmazlar Makina San. Tic. A.Ş. has right to change catalogue values and machine technical details without notice.